

Engine Control

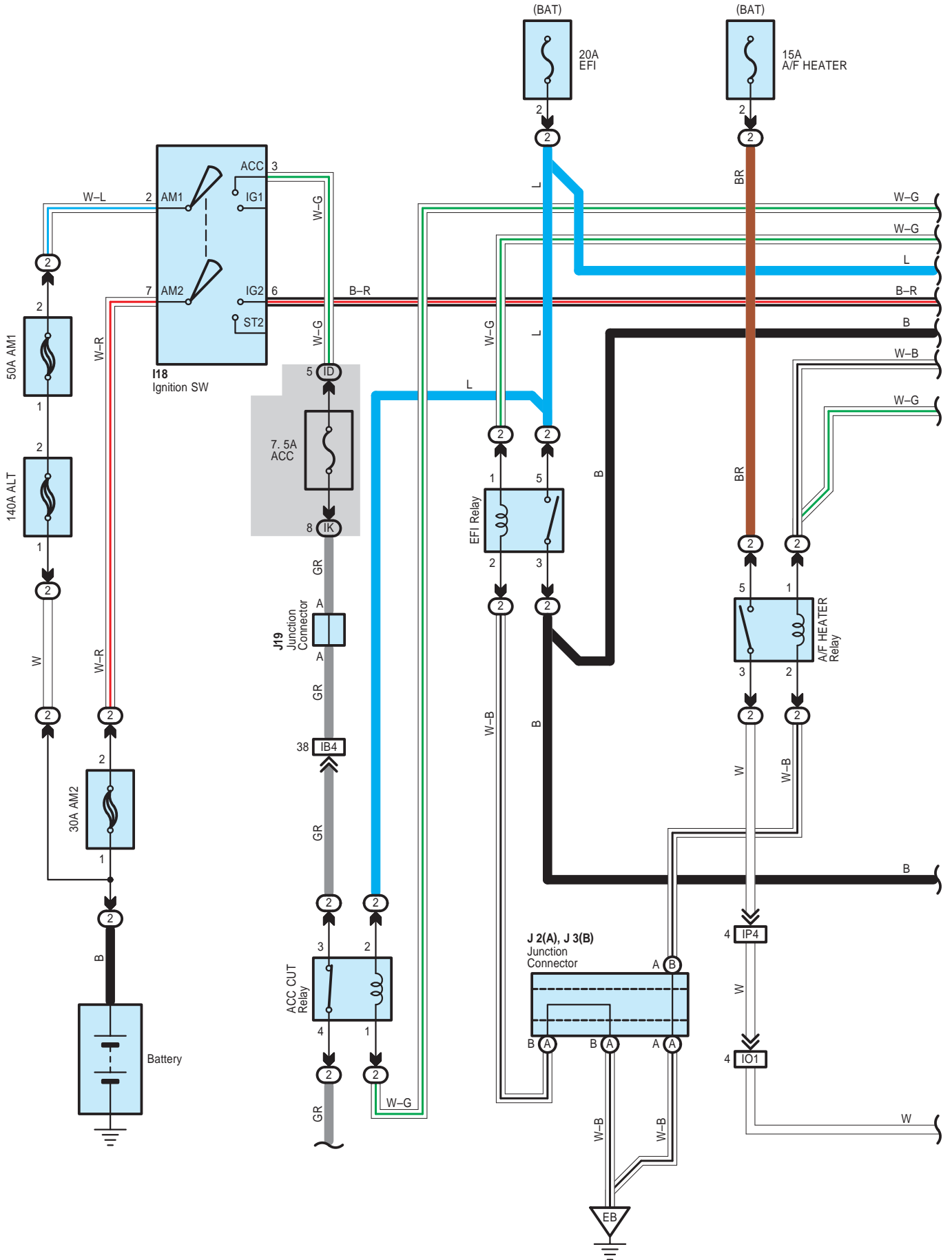

Engine Control

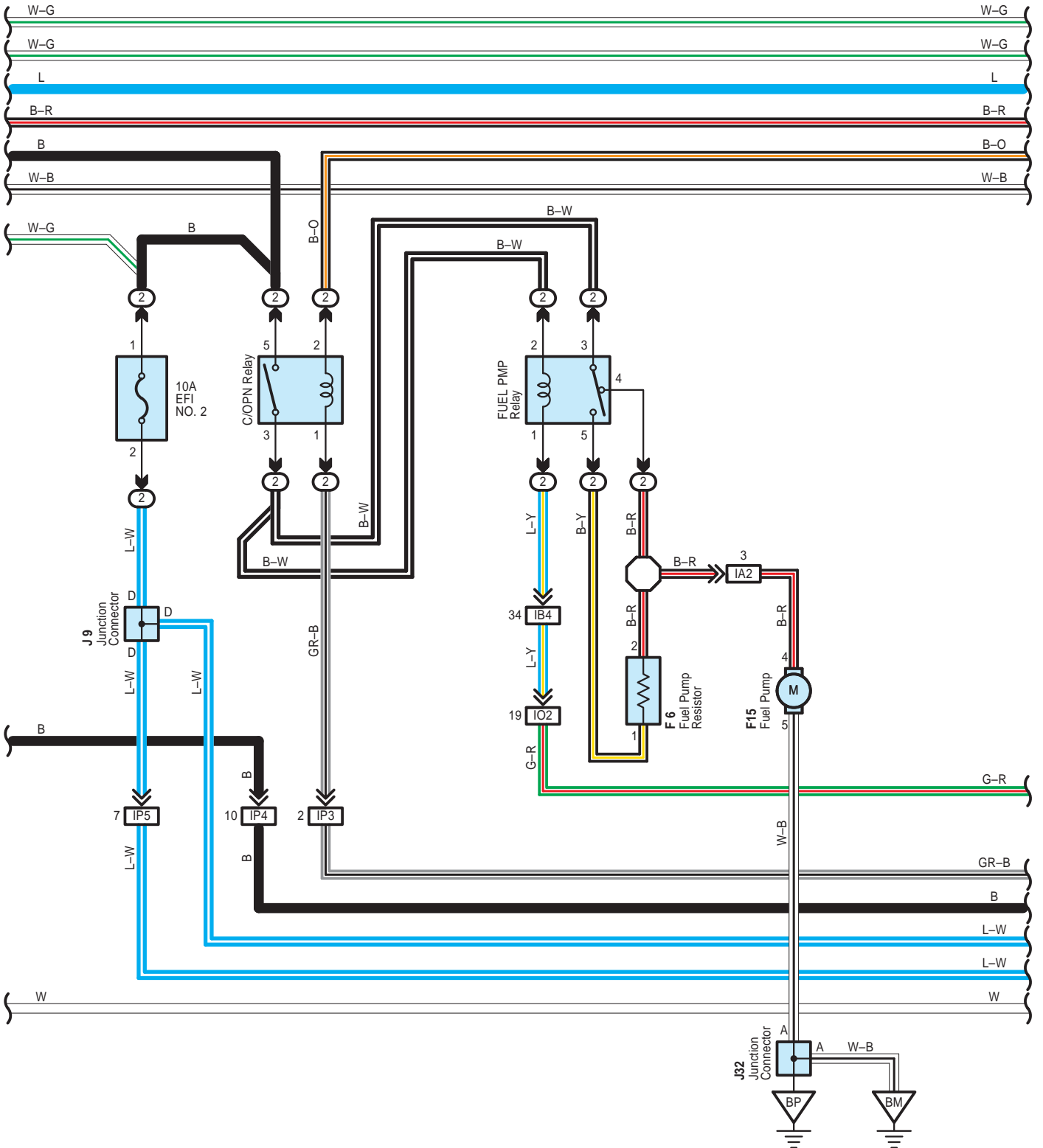

Engine Control

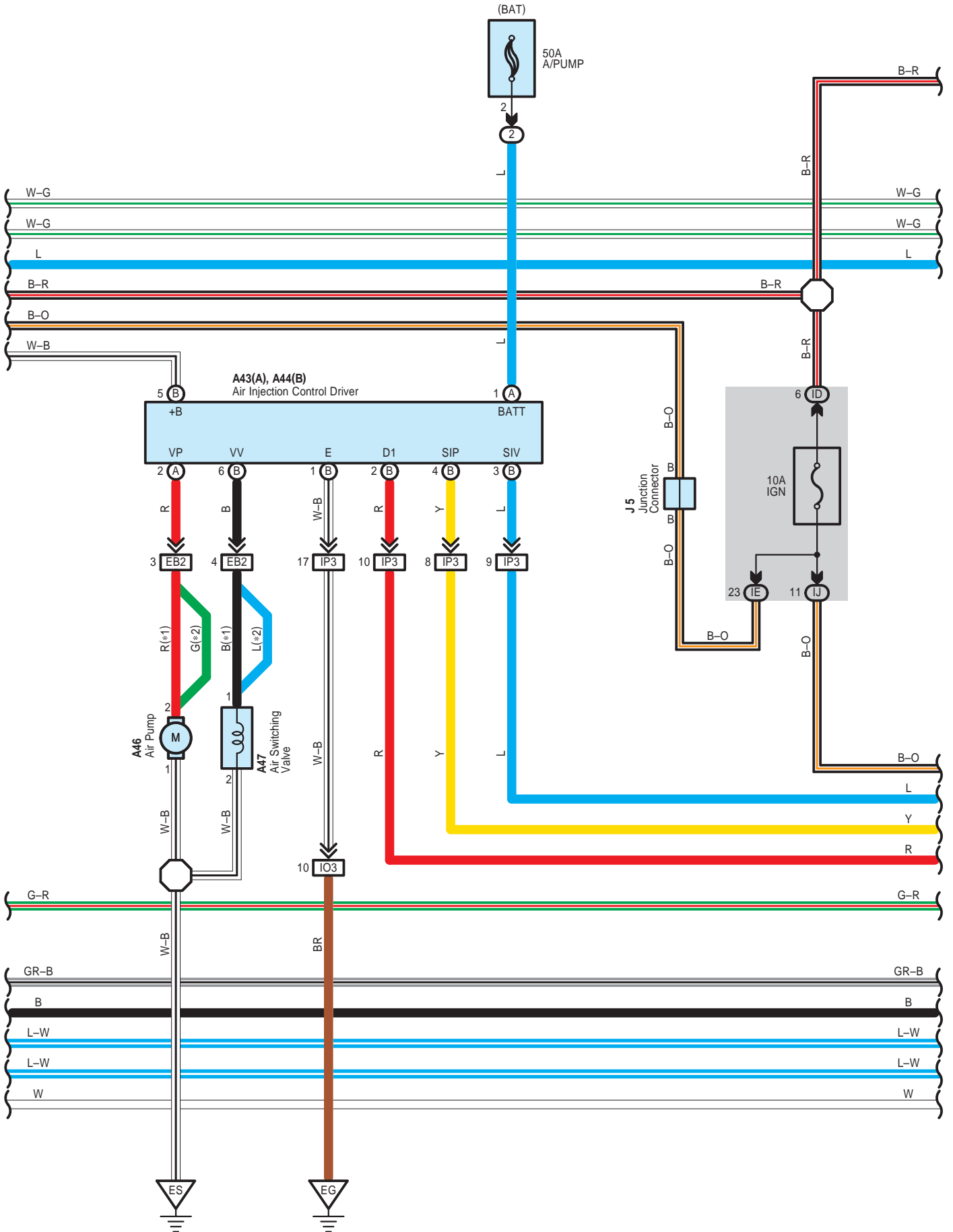

Engine Control

* 1 : w/ Kinetic Dynamic Suspension System
 * 2 : w/o Kinetic Dynamic Suspension System

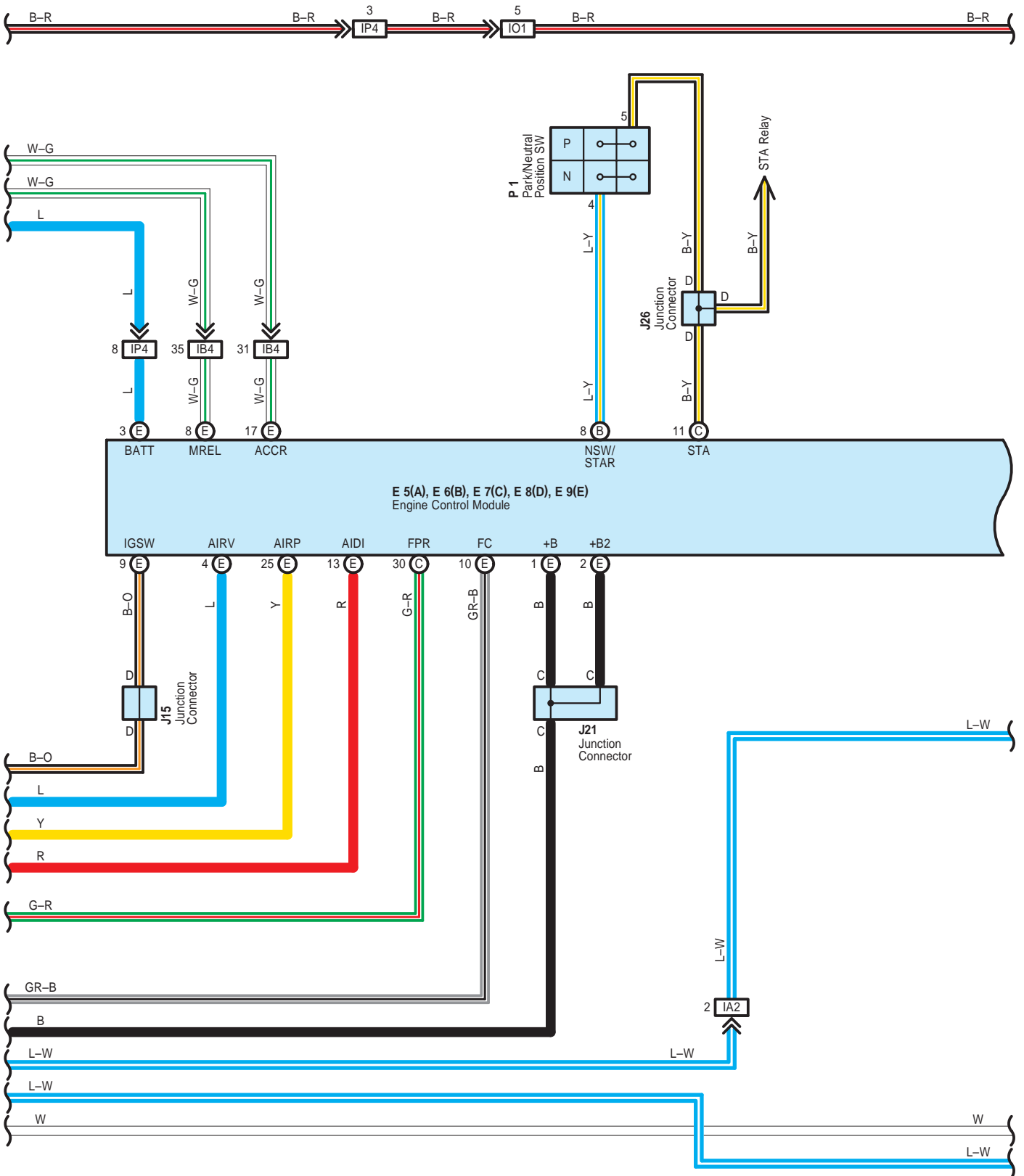

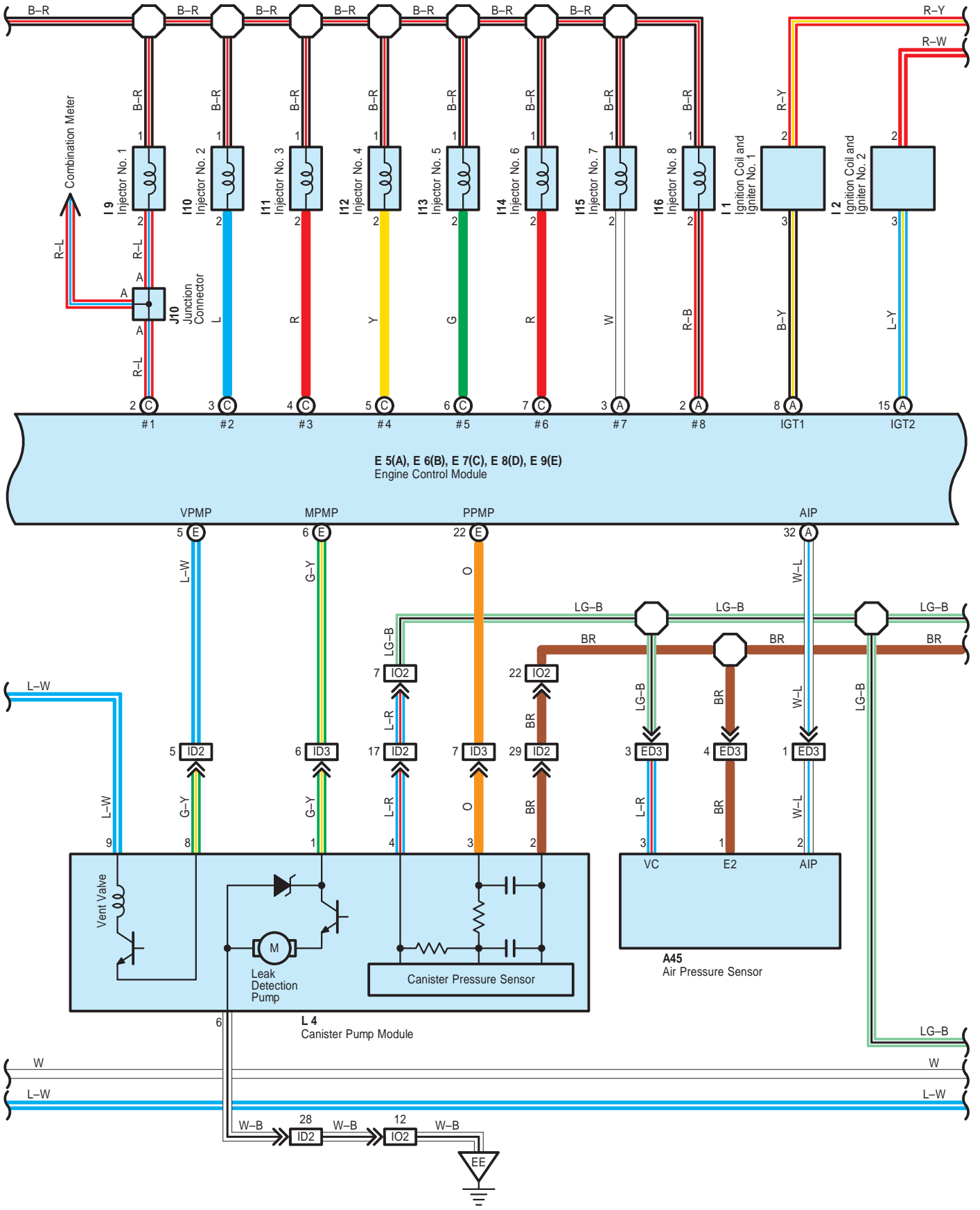

Engine Control

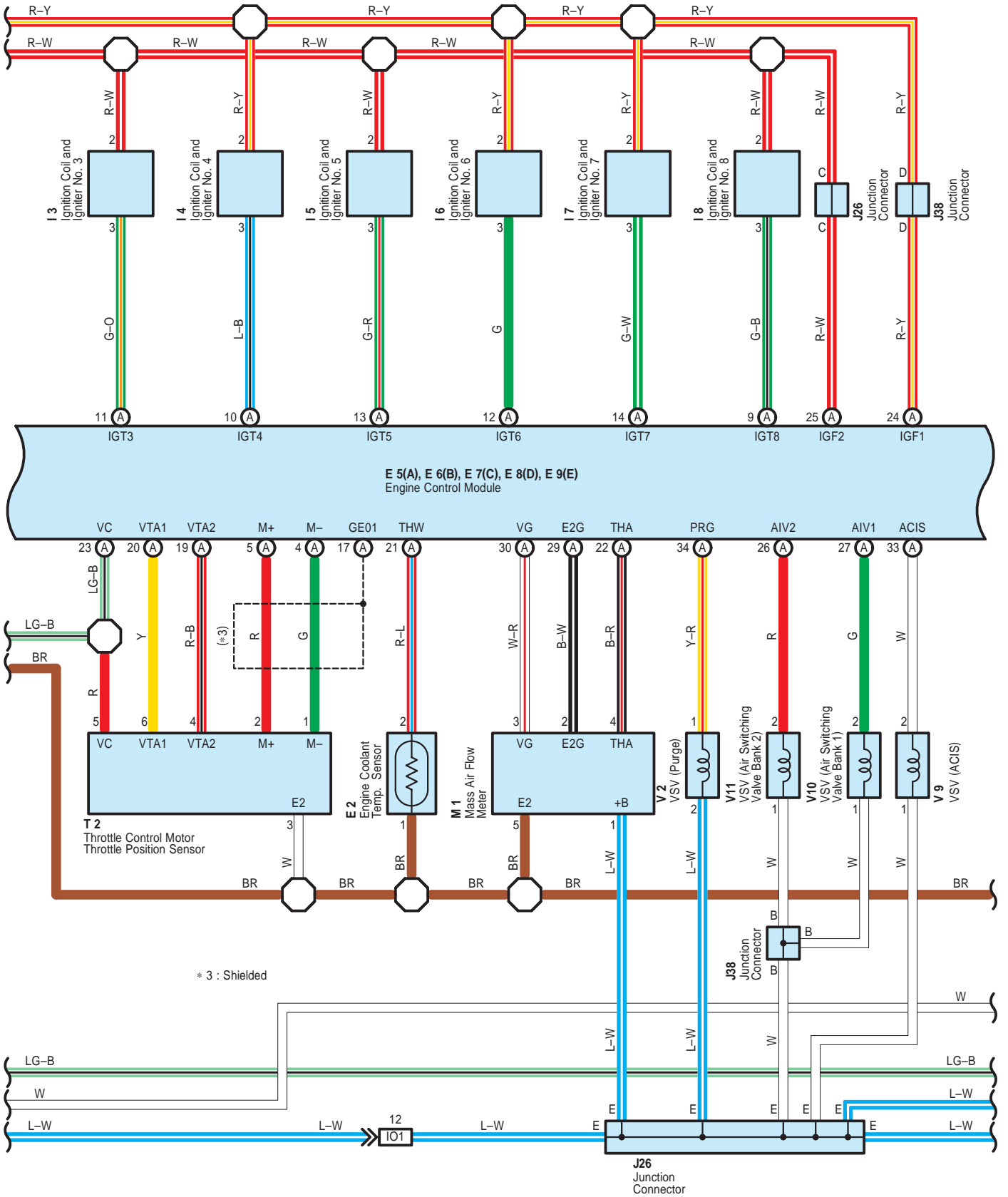

Engine Control

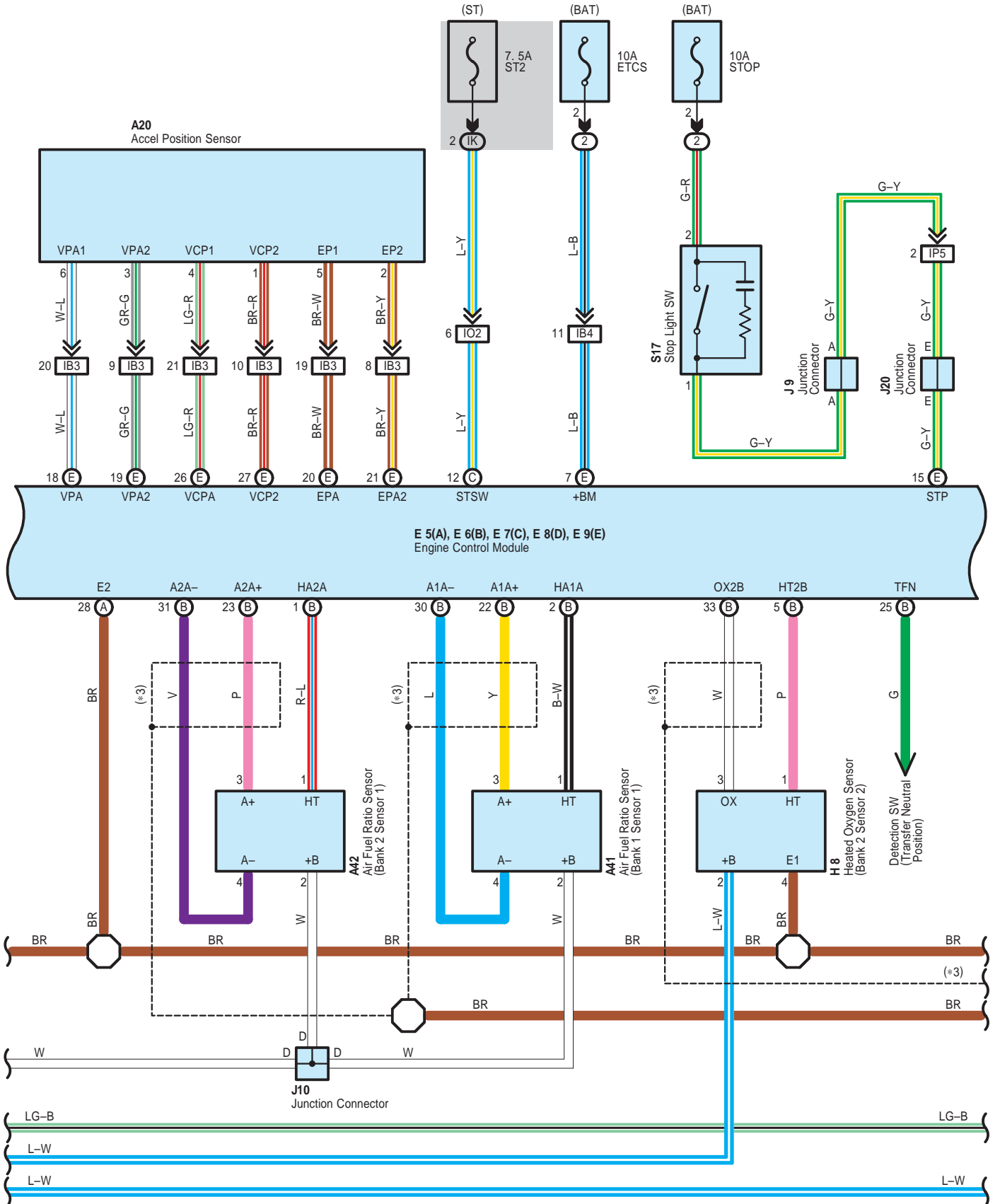

Engine Control

* 3 : Shielded

A14(B), A15(C)
 A/C Control Assembly
 (w/o LEXUS Navigation System)
 A/C ECU
 (w/ LEXUS Navigation System)

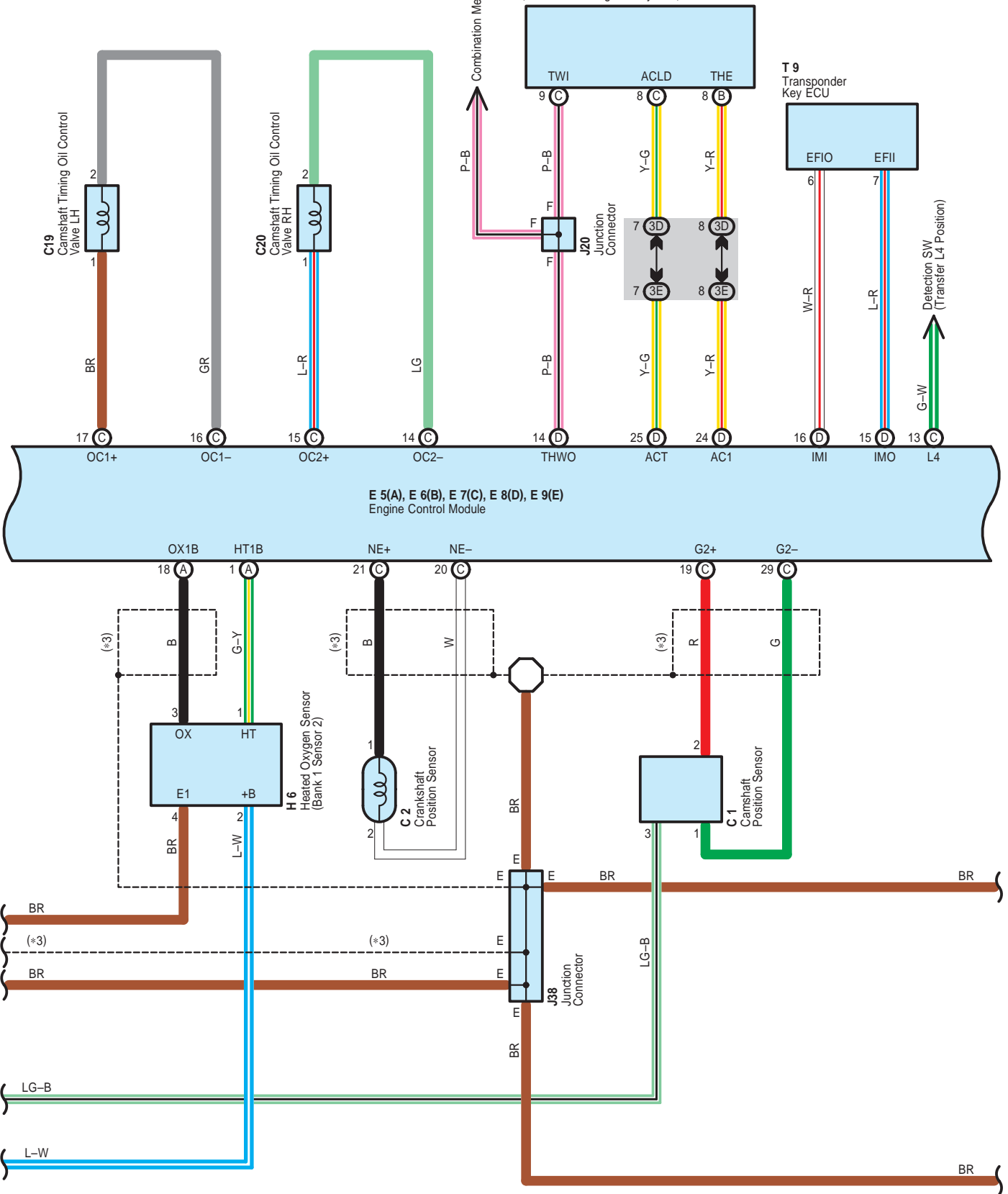

Engine Control

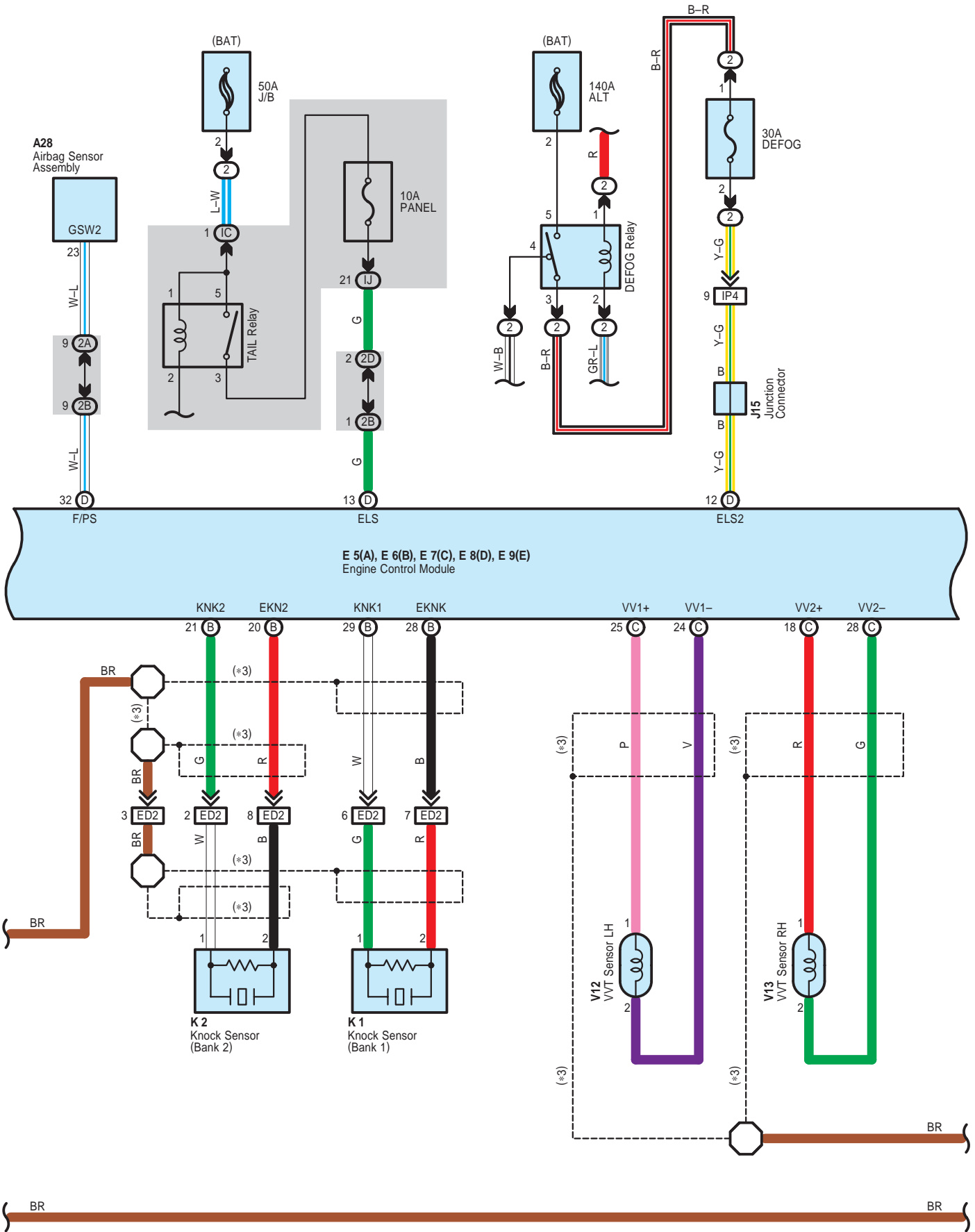

* 3 : Shielded

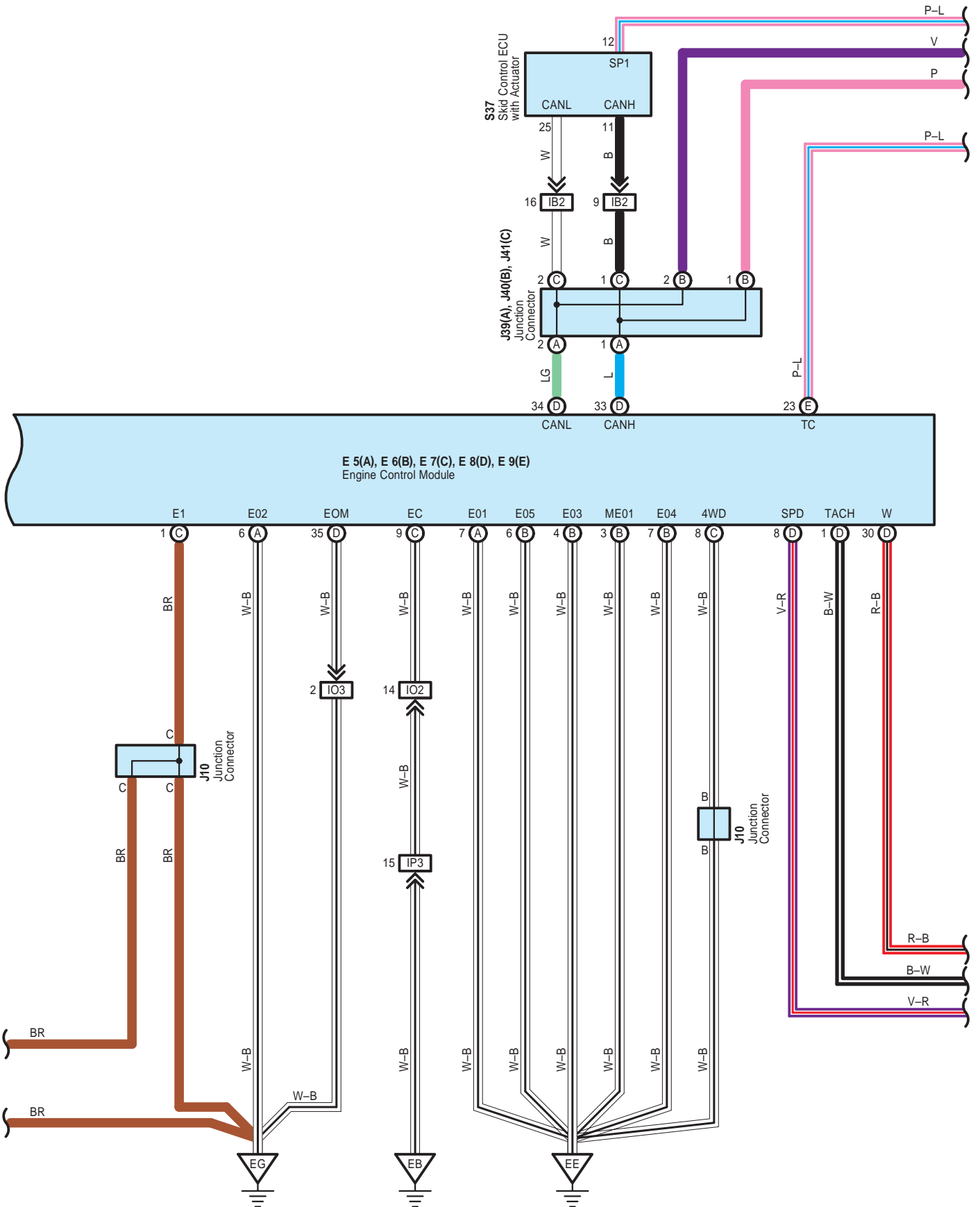

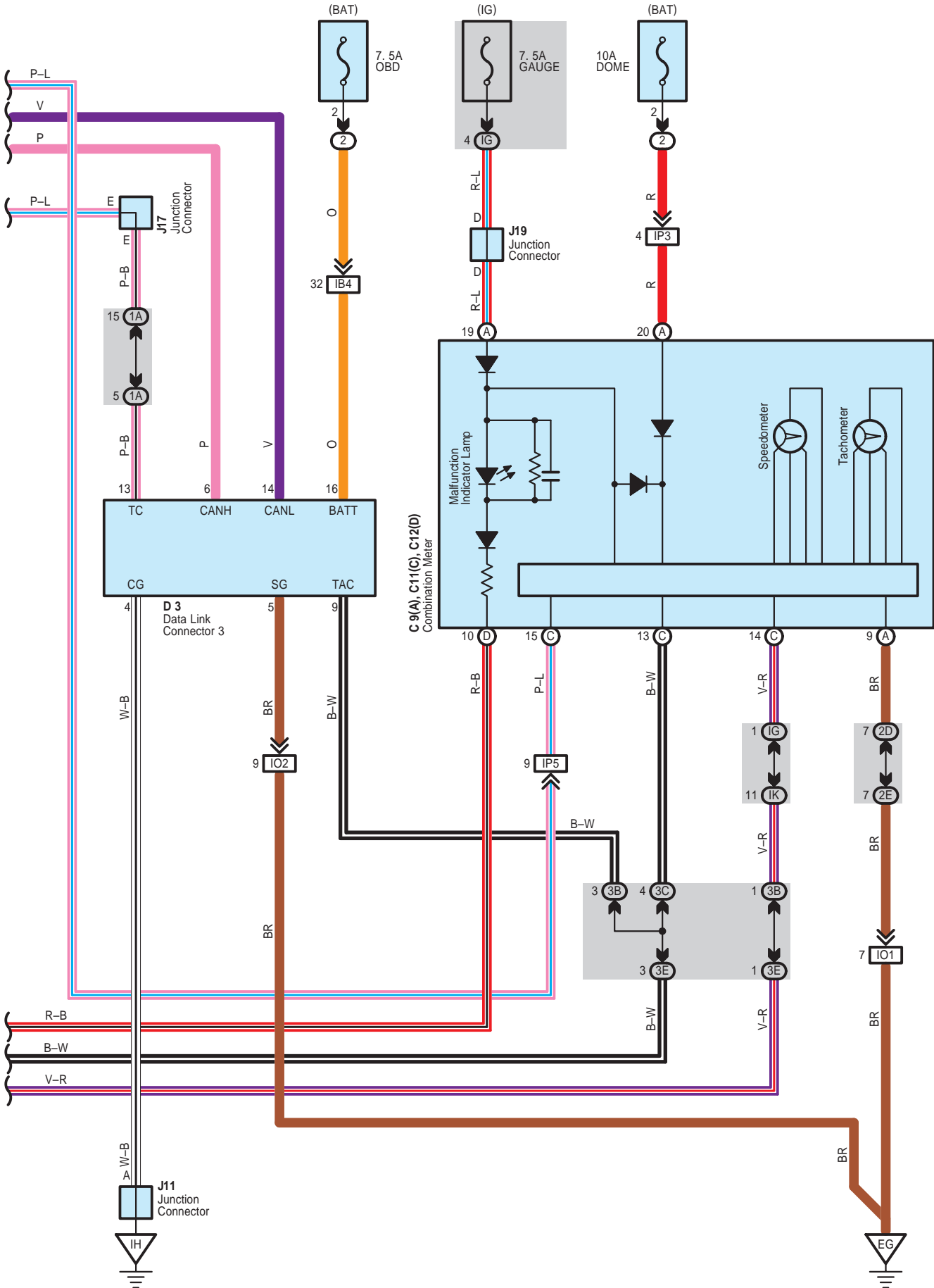

Engine Control

A 14
White

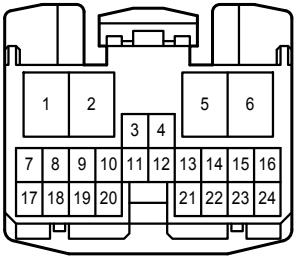

A 15
White

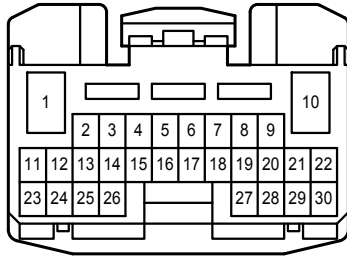

A 20
Black

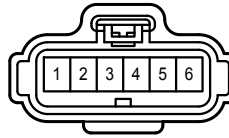

A 28
Yellow

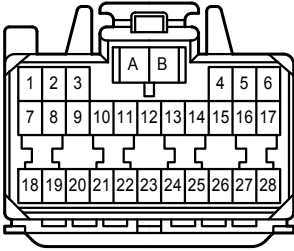

A 41
Dark Gray



A 42
Dark Gray



A 43
Gray

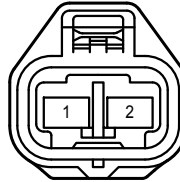

A 44
Black

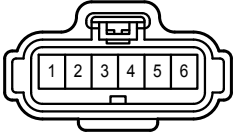

A 45
Black



A 46
Gray



A 47
Black

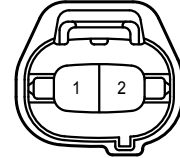

C 1
Gray



C 2
Dark Gray



C 9
White

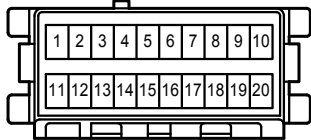

C 11
White

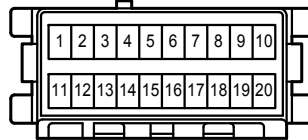

C 12
White

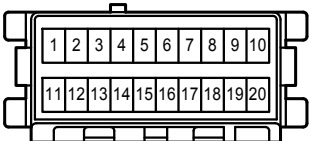

C 19
Black



C 20
Black



D 3
White

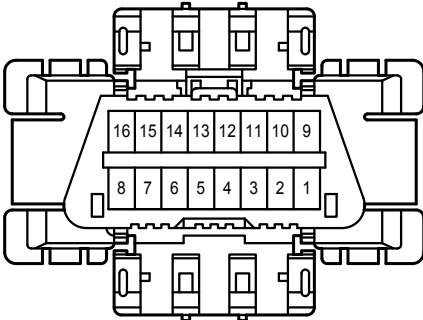

E 2
Dark Gray



E 5
White

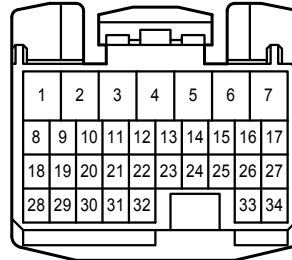

Engine Control

E 6

White

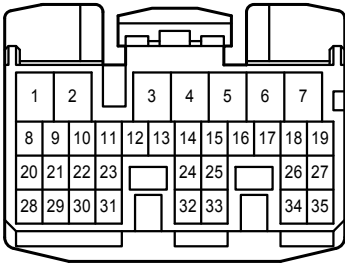

E 7

White

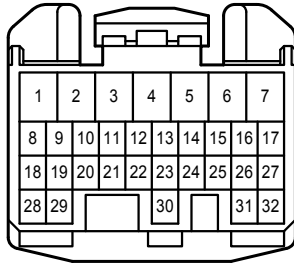

E 8

White

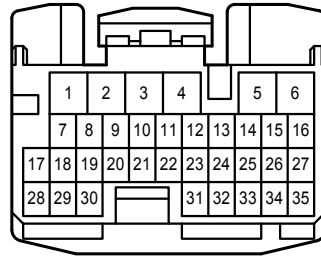

E 9

White

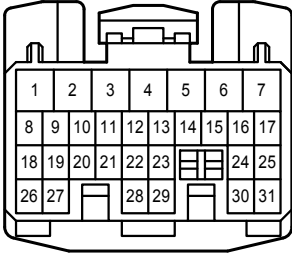

F 6

Dark Gray

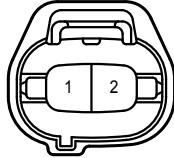

F 15

White



H 6

Dark Gray



H 8

Dark Gray



I 1

Black

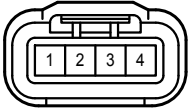

I 2

Black

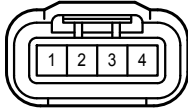

I 3

Black

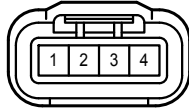

I 4

Black

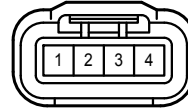

I 5

Black

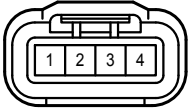

I 6

Black

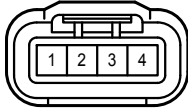

I 7

Black

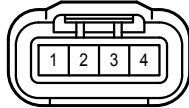

I 8

Black

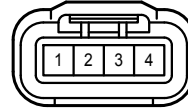

I 9

Gray

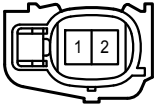

I 10

Gray

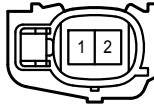

I 11

Gray

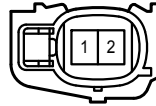

I 12

Gray

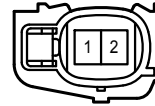

I 13

Gray

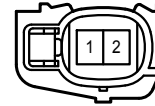

I 14

Gray

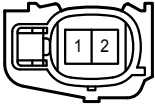

I 15

Gray

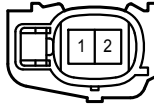

I 16

Gray

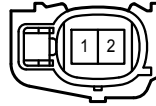

I 18

White

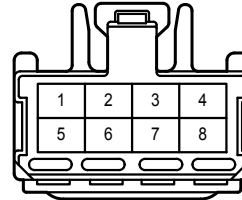

J 2

Blue

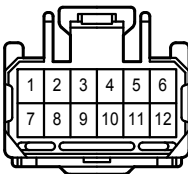

J 3

Blue

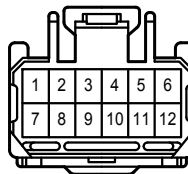

J 5

Dark Gray



J 9

Black

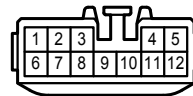

Engine Control

J 10
Blue

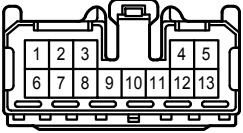

J 11
White

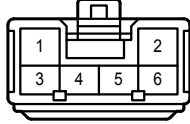

J 15
Blue

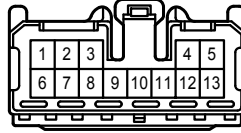

J 17
Black

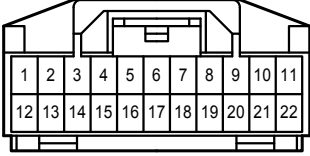

J 19
Black

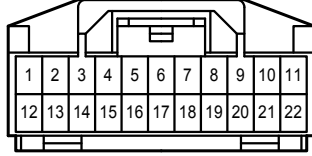

J 20
Black

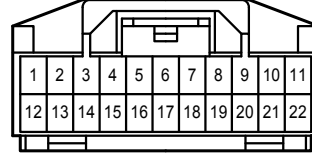

J 21
Blue

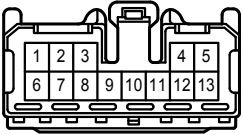

J 26
White

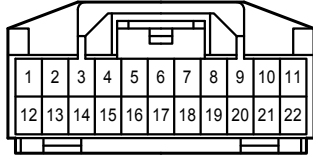

J 32
White

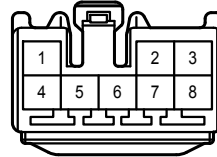

J 38
White

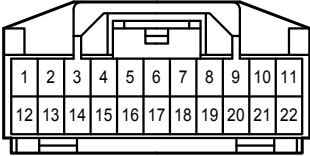

J 39
White

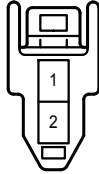

J 40
White

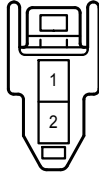

J 41
White

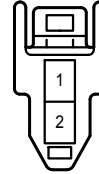

K 1
Black

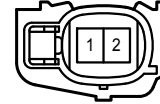

K 2
Gray

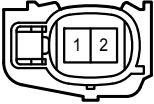

L 4
Black



M 1
Black



P 1
Gray

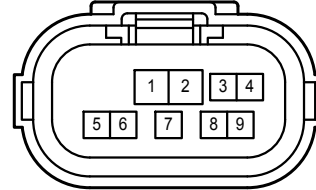

S 17
Blue

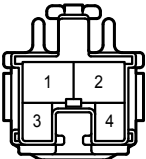

S 37
Black

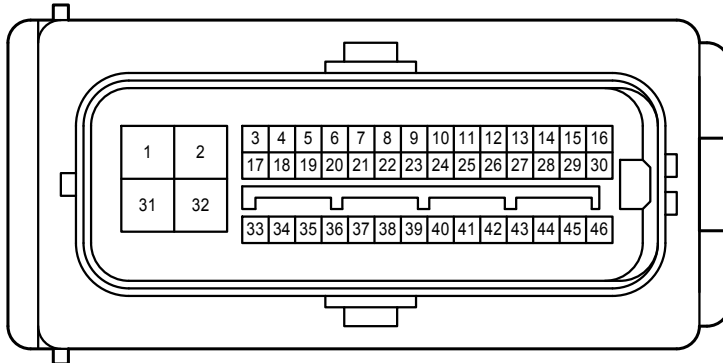

Engine Control

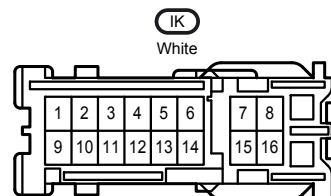
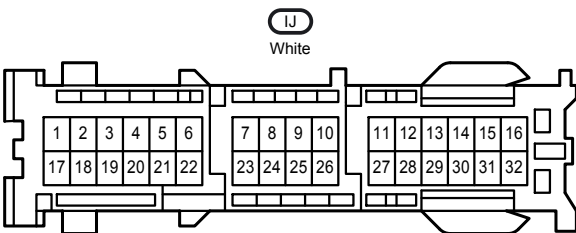
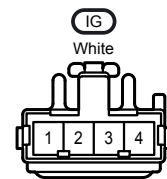
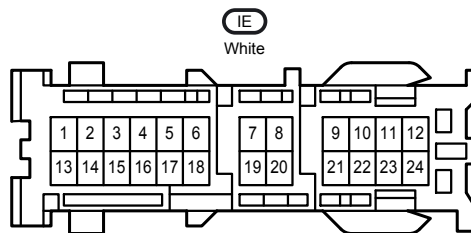
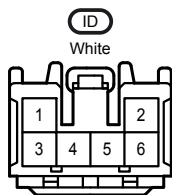
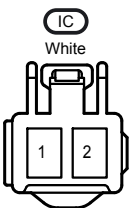
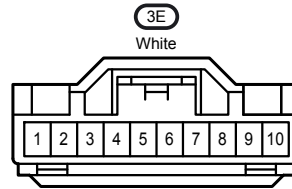
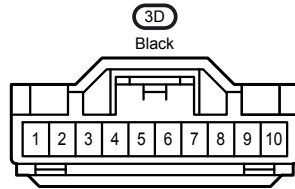
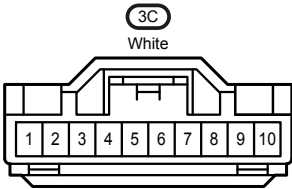
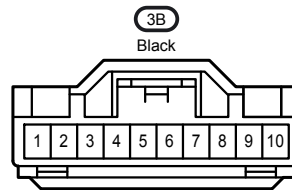
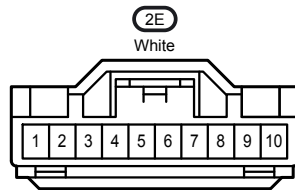
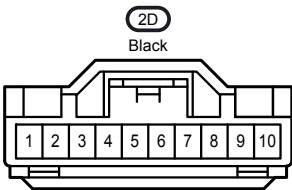
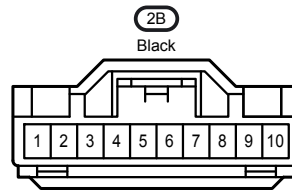
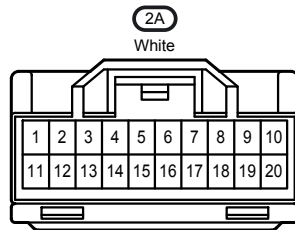
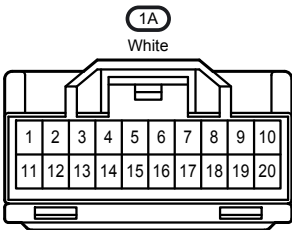
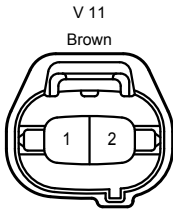
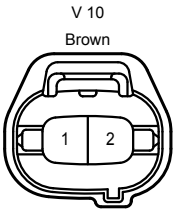
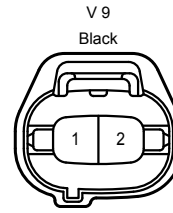
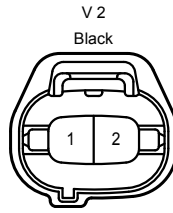
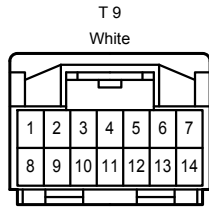
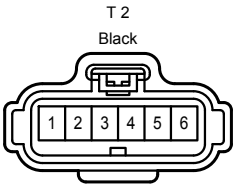

Engine Control

EB2
Gray

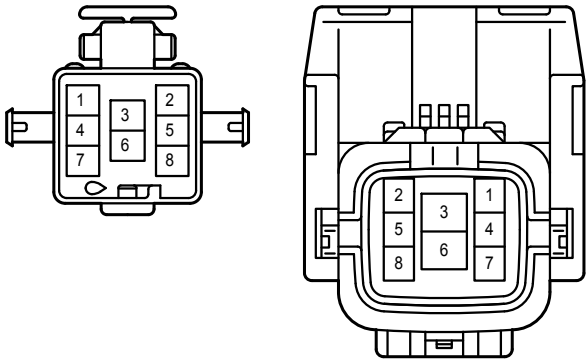

ED2
Gray

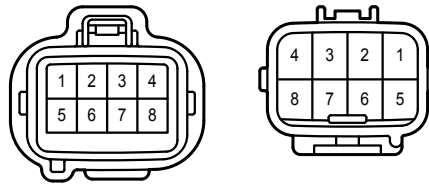

ED3
Gray

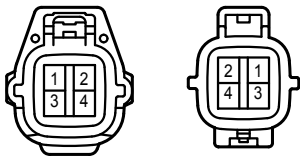

IA2
White

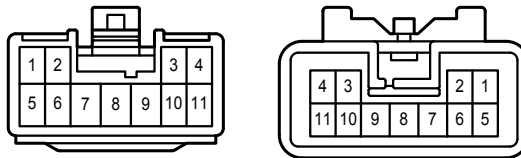

IB2
Blue

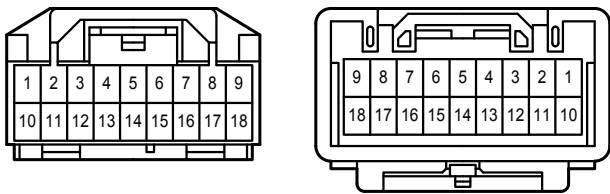

IB3
Gray

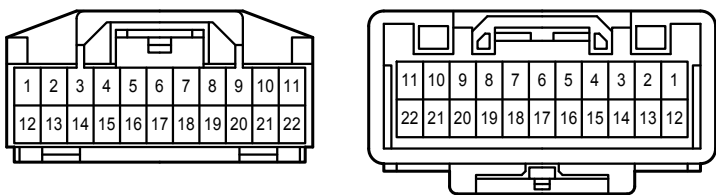

IB4
White

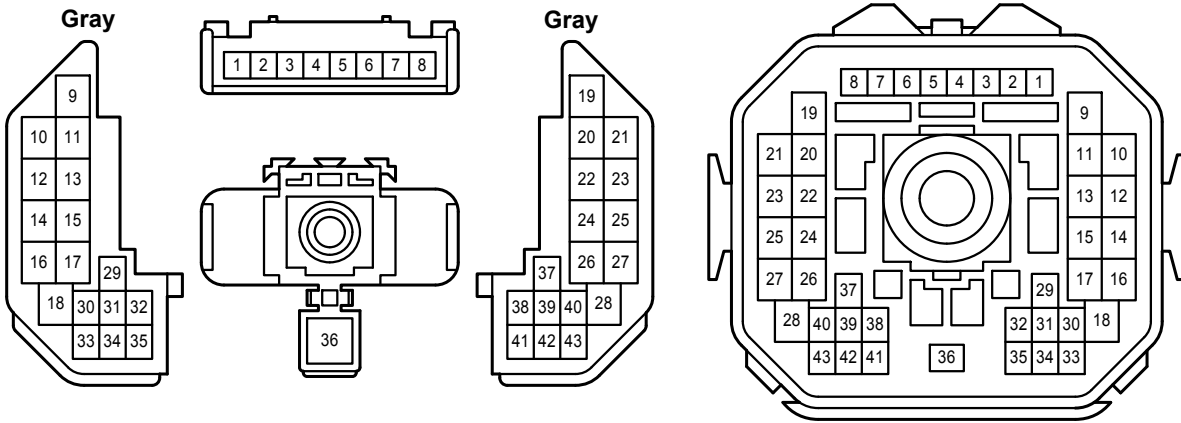

ID2
White

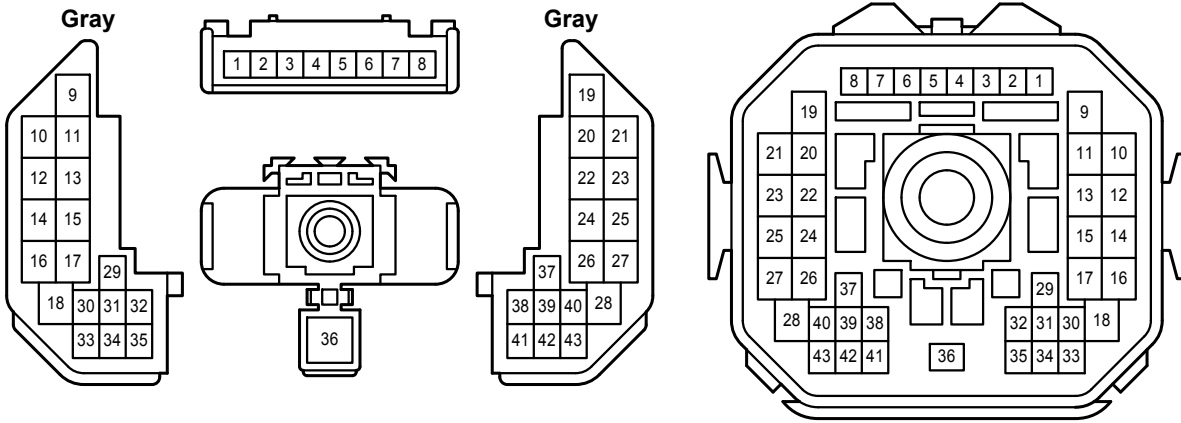

ID3
White

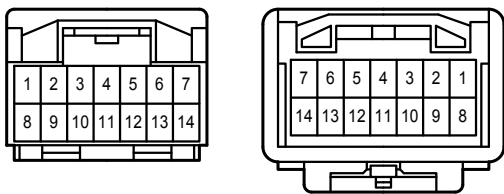

IO1
White

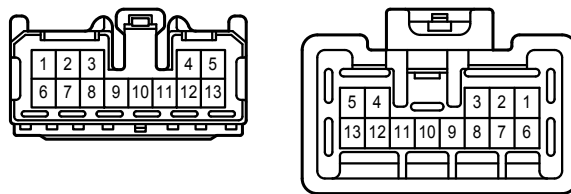

IO2
White

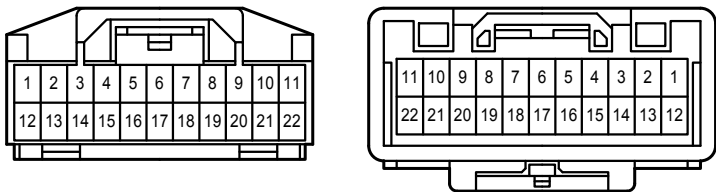

IO3
White

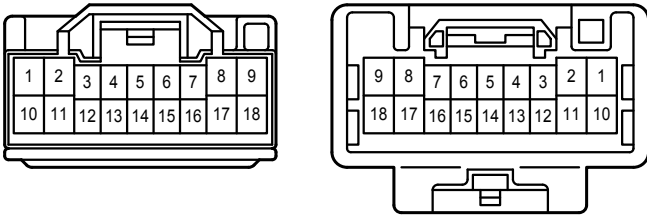

IP3
White

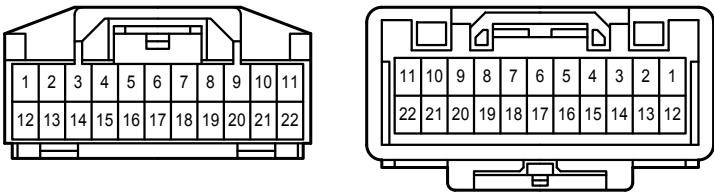

IP4
Blue

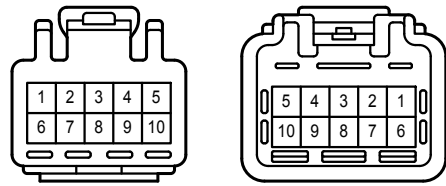

IP5
Black

